

Name: \_\_\_\_\_

Date: \_\_\_\_\_

# Geometry

Read the protractor and write the correct angle.

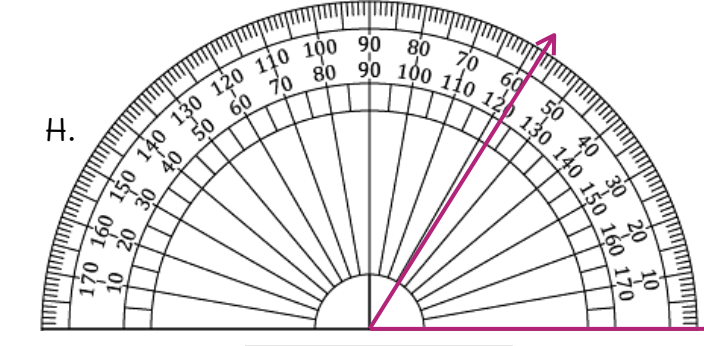
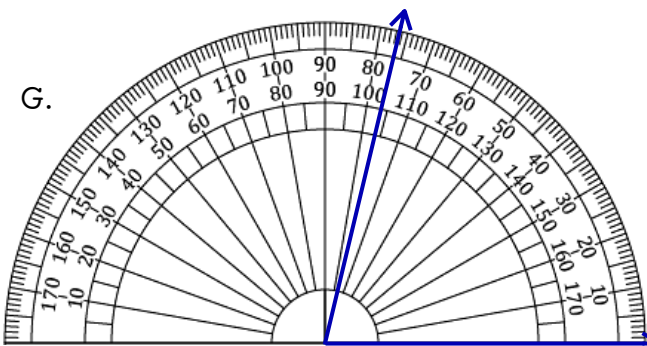
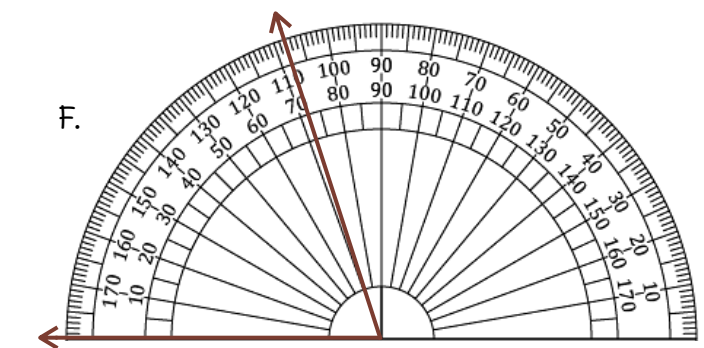
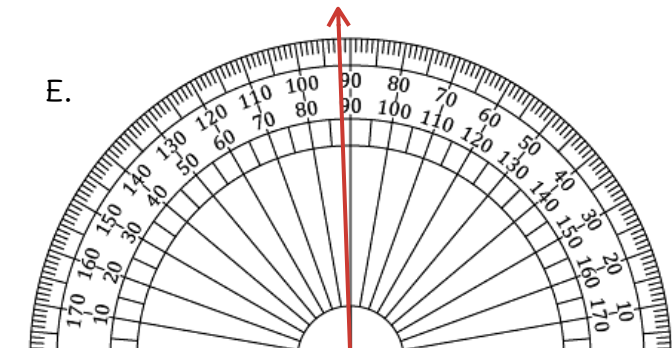
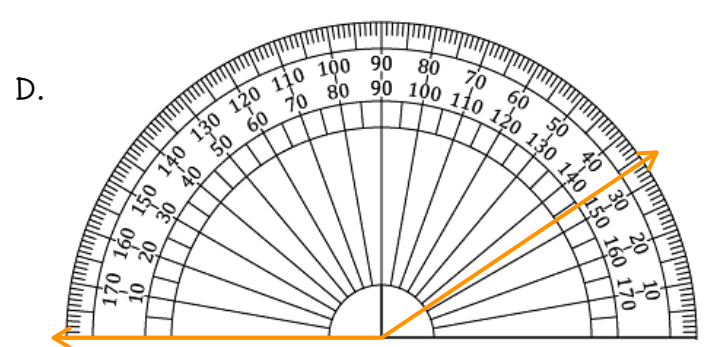
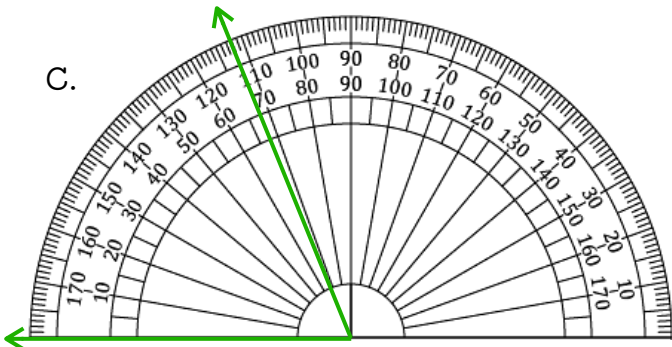
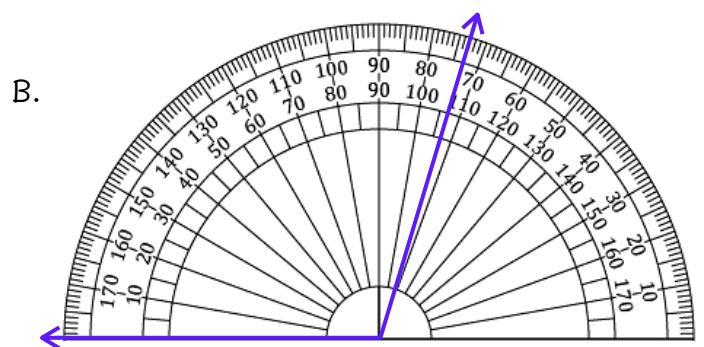
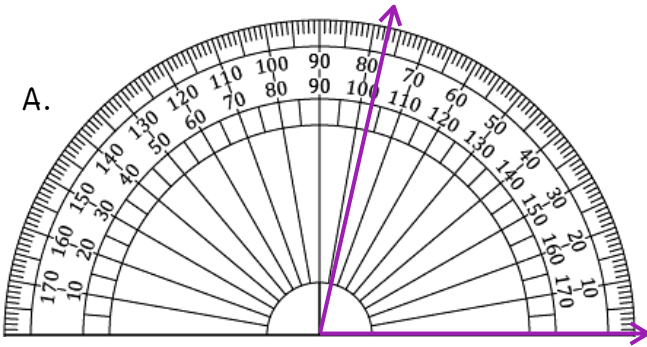

Name: \_\_\_\_\_

Date: \_\_\_\_\_

# Geometry

Read the protractor and write the correct angle.

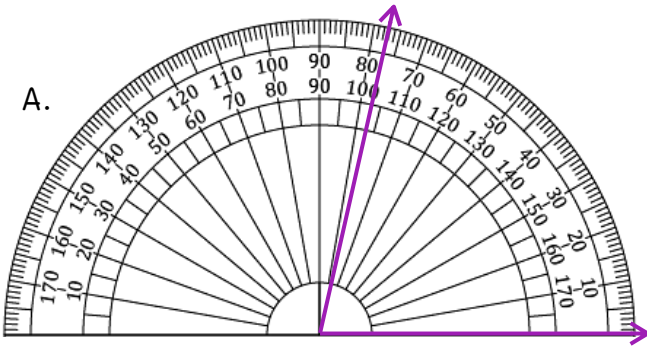

77°

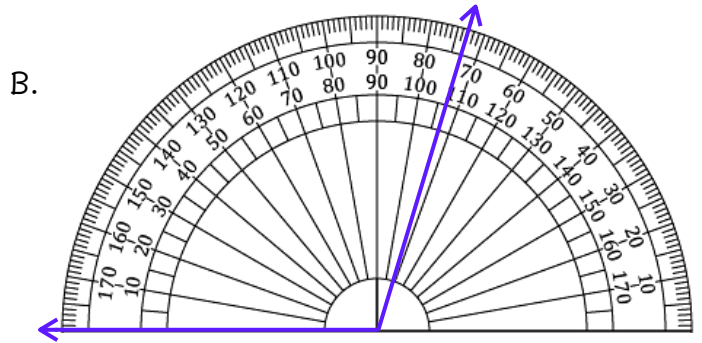

107°

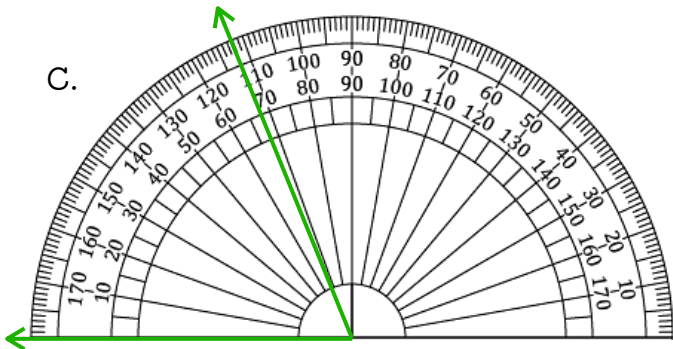

68°

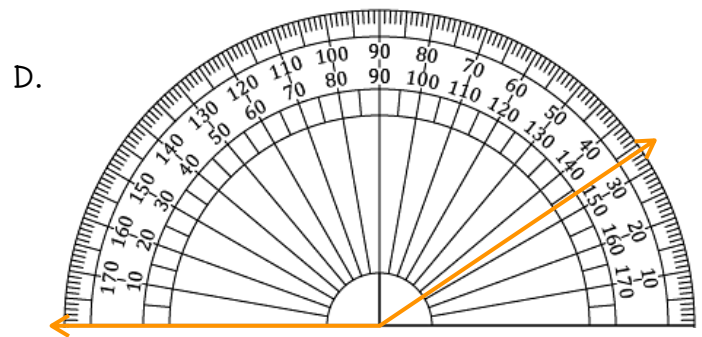

146°

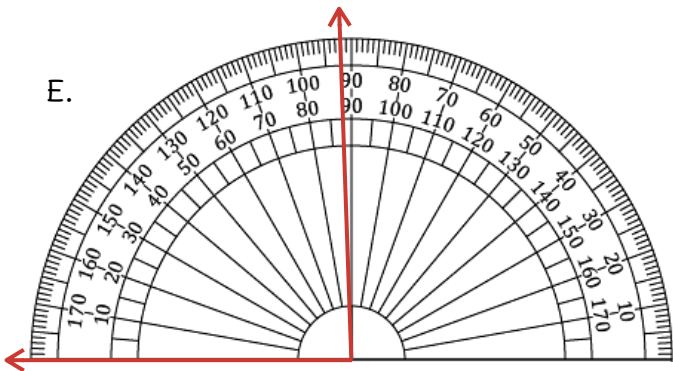

88°

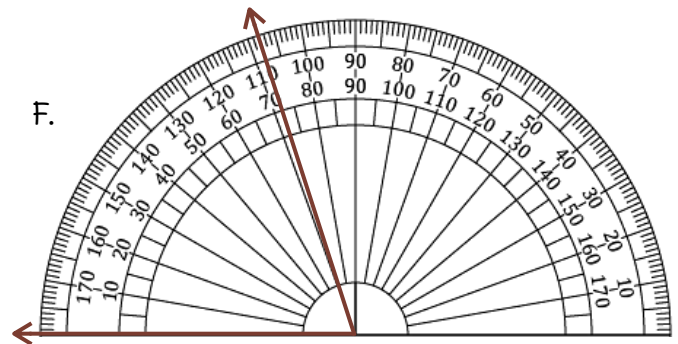

72°

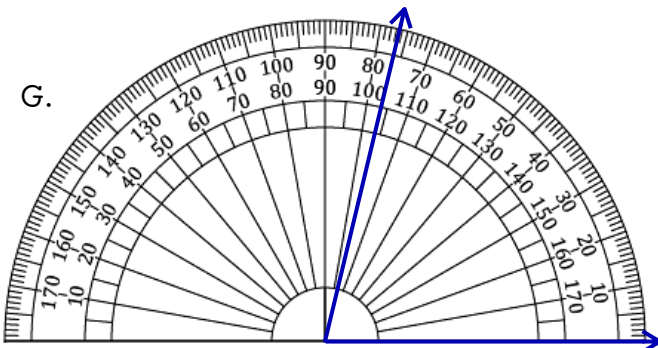

76°

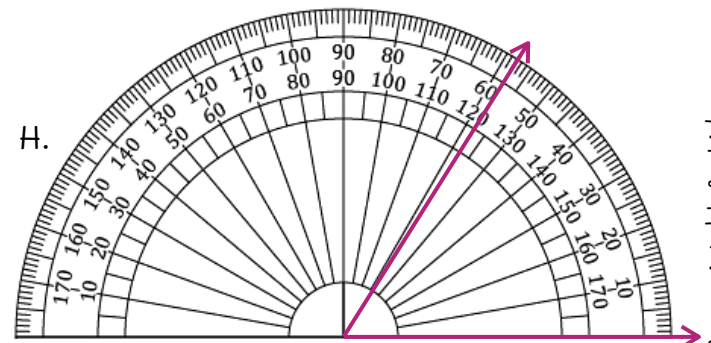

62°